



Product information presented here reflects conditions at time of publication. Consult factory regarding discrepancies or inconsistencies.

PUMP COMPANY

Zoeller Family of Water Solutions™

MAIL TO: P.O. BOX 16347 • Louisville, KY 40256-0347
SHIP TO: 3649 Cane Run Road • Louisville, KY 40211-1961
(502) 778-2731 • 1 (800) 928-PUMP • FAX (502) 774-3624

visit our web site:
www.zoeller.com

AERATION/FOUNTAIN PUMP MODEL 370-0002

INSTALLATION INSTRUCTIONS

These installation instructions are applicable for Model 370-0002 Aeration/Fountain Pump only.
This pump system is designed for decorative use and can improve water aeration.





PREINSTALLATION CHECKLIST - ALL INSTALLATIONS

ATTENTION: READ CAREFULLY BEFORE ATTEMPTING TO INSTALL OR OPERATE YOUR PUMP. PROTECT YOURSELF AND OTHERS BY OBSERVING ALL SAFETY INFORMATION AND ADDITIONAL INSTRUCTIONS INCLUDED WITH EQUIPMENT. FAILURE TO COMPLY WITH INSTRUCTIONS COULD RESULT IN PERSONAL INJURY AND/OR PROPERTY DAMAGE! RETAIN FOR FUTURE REFERENCE.



WARNING

SEE BELOW FOR LIST OF WARNINGS

- | | |
|--|--|
| <ol style="list-style-type: none"> 1. Make sure that the pump is plugged into a properly grounded electrical receptacle. Use an Underwriters Laboratory listed circuit analyzer to test for proper installation of the circuit and ground. Any service to circuits or receptacles should be conducted by a qualified licensed electrician. 2. Do not remove the ground pin from the plug under any circumstances. If the ground pin is damaged, replace the power cord or plug before use. 3. All electrical installations must conform to the requirements of the National Electric Code and all local codes. 4. System furnished with a 100 ft. power cord with 3-prong GFCI plug; must connect to properly grounded receptacle of grounding type. Do not remove ground pin on plug. Do not extend the cord length by splicing or with an extension cord. 5. Disconnect power before servicing the pump or motor by unplugging the unit from the outlet. 6.  Do not touch the motor when operating and allow the motor to cool before touching. 7. Pump is built to handle clear water only; it is not designed to handle water containing sand, silt, or other abrasives. 8.  Do not use to pump flammable or explosive fluids such as gasoline, kerosene, fuel oil, etc. Do not use in flammable and/or explosive atmospheres. 9.  Do not use this product in hazardous environments or anywhere a spark could potentially ignite explosive gases. 10. Do not handle this product with wet hands or while standing in water or on a wet or damp surface. | <ol style="list-style-type: none"> 11. Units are supplied with an automatically resetting thermal overload device and can restart without warning. 12.  Provide a means of pressure relief if the pump discharge can be shut off or obstructed. Pumps operating against a closed discharge can create very hot pumped liquid, which can cause burns. 13. "No swimming" and/or warning signs should be posted per state and local codes. Please affix included warning label to power receptacle or junction box. 14. Do not ground to a gas supply line. 15. Protect the power cable from coming in contact with sharp objects, oil, grease, hot surfaces, or chemicals. DO NOT kink the power cable. If damaged, replace immediately. 16. According to the state of California (Prop 65), this product contains chemicals known to the state of California to cause cancer and birth defects or other reproductive harm. 17. NEVER leave the control box, fused disconnect switch or cover open (either partially or completely) when not being worked on by a competent electrician. 18. Water leaving nozzle is at a high velocity and can cause bodily injury if contact is made. 19. Never examine, make wiring changes, or touch the motor before disconnecting the main electrical supply switch. The thermal device may have opened the electrical circuit. All motors should be equipped with a correctly fused disconnect switch to provide protection. Consult local or United States National Electrical Codes for proper fuse protection based on motor data chart. 20. GFI plug must be oriented with cord coming out of the bottom and protected from direct rainfall. |
|--|--|

CAUTION

SEE BELOW FOR LIST OF CAUTIONS

- | | |
|--|--|
| <ol style="list-style-type: none"> 1. Make certain that the power source conforms to the requirements of the equipment as stated on the product nameplates and wire motor for correct voltage. See motor nameplate. 2. Periodically inspect the pump for damage and perform routine maintenance as required. 3. The maximum temperature of the pumped liquid must not exceed 120°F. | <ol style="list-style-type: none"> 4. Supply voltage must be within +/- 10% of nameplate voltage. Incorrect voltage can cause fire or seriously damage motor and voids warranty. If in doubt, consult a licensed electrician. |
|--|--|

REFER TO WARRANTY ON PAGE 2.

LIMITED WARRANTY

Manufacturer warrants, to the purchaser and subsequent owner during the warranty period, every new product to be free from defects in material and workmanship under normal use and service, when properly used and maintained, for a period of one year from date of purchase by the end user, or 18 months from date of original manufacture of the product, whichever comes first. Parts that fail within the warranty period, one year from date of purchase by the end user, or 18 months from the date of original manufacture of the product, whichever comes first, that inspections determine to be defective in material or workmanship, will be repaired, replaced or remanufactured at Manufacturer's option, provided however, that by so doing we will not be obligated to replace an entire assembly, the entire mechanism or the complete unit. No allowance will be made for shipping charges, damages, labor or other charges that may occur due to product failure, repair or replacement.

This warranty does not apply to and there shall be no warranty for any material or product that has been disassembled without prior approval of Manufacturer, subjected to misuse, misapplication, neglect, alteration, accident or act of God; that has not been installed, operated or maintained in accordance with Manufacturer's installation instructions; that has been exposed to outside substances including but not limited to the following: sand, gravel, cement, mud, tar, hydrocarbons, hydrocarbon derivatives (oil, gasoline, solvents, etc.), or other abrasive or corrosive substances, wash towels or feminine sanitary products, etc. in all pumping applications.

The warranty set out in the paragraph above is in lieu of all other warranties expressed or implied; and we do not authorize any representative or other person to assume for us any other liability in connection with our products.

Contact Manufacturer at, 3649 Cane Run Road, Louisville, Kentucky 40211, Attention: Customer Support Department to obtain any needed repair or replacement of part(s) or additional information pertaining to our warranty.

MANUFACTURER EXPRESSLY DISCLAIMS LIABILITY FOR SPECIAL, CONSEQUENTIAL OR INCIDENTAL DAMAGES OR BREACH OF EXPRESSED OR IMPLIED WARRANTY; AND ANY IMPLIED WARRANTY OF FITNESS FOR A PARTICULAR PURPOSE AND OF MERCHANTABILITY SHALL BE LIMITED TO THE DURATION OF THE EXPRESSED WARRANTY.

Some states do not allow limitations on the duration of an implied warranty, so the above limitation may not apply to you. Some states do not allow the exclusion or limitation of incidental or consequential damages, so the above limitation or exclusion may not apply to you.

This warranty gives you specific legal rights and you may also have other rights which vary from state to state.

SAFETY INSTRUCTIONS

Carefully read and follow all safety instructions in this manual and on pump. Keep safety labels in good condition. Replace missing or damaged safety labels.



This is a SAFETY ALERT SYMBOL. When you see this symbol on the pump or in the manual, look for one of the following signal words and be alert to the potential for personal injury or property damage.



WARRNS of hazards that **WILL** cause serious personal injury, death, or major property damage if ignored.



WARRNS of hazards that **CAN** cause serious personal injury or death if ignored.



WARRNS of hazards that **MAY** cause minor personal injury, product or property damage if ignored.

IMPORTANT: Indicates factors concerned with operation, installation, assembly or maintenance which could result in damage to the machine or equipment if ignored.

NOTE: Indicates special instructions which are important but not related to hazards.

TROUBLE SHOOTING GUIDE



WARNING ELECTRICAL PRECAUTIONS- Before servicing a pump, always shut off the main power breaker and then unplug the pump. Make sure you are not standing in water and are wearing insulated protective sole shoes. Under flooded conditions, contact your local electric company or a qualified licensed electrician for disconnecting electrical service prior to pump removal.

SYMPTOM	POSSIBLE CAUSES	CORRECTIVE ACTION
Unit won't run.	Circuit breaker tripped.	Reset circuit breaker.
	GFCI tripped.	Reset GFCI
No or low spray.	Blocked screen or nozzle, missing or damaged o-ring, or incorrectly installed nozzle	Disconnect power. Clean screen and/or nozzle. Check that o-ring is undamaged and seated in groove. Check that nozzle is installed properly. (nozzles are marked "This side up"). Check depth of pond. If less than 5' deep, move to deeper section. Restart unit.
GFCI trips.	Electrical storm can trip GFCI.	Reset GFCI.
	Short in system.	Disconnect power and inspect cord for damage. If cord is damaged contact Customer Service Help Line at 1-800-928-7867.
Unit spins.	Anchor rope loose	Check anchor rope and re-attach if necessary

INSTALLATION

1. Only install this system in ponds where no swimming, wading, boating, or fishing is allowed. Disconnect power to the pump before fishing or entering the water.
2. Post appropriate warning signs per local and state codes.
3. Inspect pump system for damage before installing in pond. Check that all bolts and screws are tight. Check for any bent prongs or a cracked case on the GFCI.
4. The unit ships with one spray nozzle attached. To change to one of the other two nozzles, remove the four screws from the nozzle then replace with the desired nozzle. Refer to Figures 2, 3, and 4 for spray pattern appearance. Nozzles are marked "This side up." Make sure the o-ring is seated in the groove before installing nozzle. Tighten screws until seated, approximately 10 to 12 in-lbs.
5. Attach nylon anchor ropes to two eyebolts located at top of screen. Secure (make sure rope is tight) to weights placed on pond floor or stakes on pond shore. When using weights to anchor the pump, place weights approximately ten feet from unit, 180 degrees apart.
6. Before connecting the unit to the power receptacle, check to ensure there is no leakage to the ground. This can be done by using an ohm meter and setting the scale to the highest setting (i.e. Rx100K). Connect one ohm meter lead to the unit power cord ground (round prong) and to one of the flat prongs. It should read infinite or at least two megohms. Repeat with the other prong. If reading is below two megohms on either prong, contact Technical Service Help Line at 800-928-7867.
7. Do Not Operate System on an Extension Cord! If no power is accessible at the pond, contract a licensed electrician to install the proper power supply in accordance with the National Electrical Code and all applicable local codes and ordinances.
8. After installing the unit, checking ground and connecting power to the unit, the unit can be powered up. Check operation of the GFCI by pushing the "Test" button, the unit should stop. Pushing the "Reset" button should restart the unit. If pressing the "Test" button does not stop the unit, immediately shut off power to the unit and contact Technical Support Help Line at 800-928-7867.

Figure 1: Typical Installation

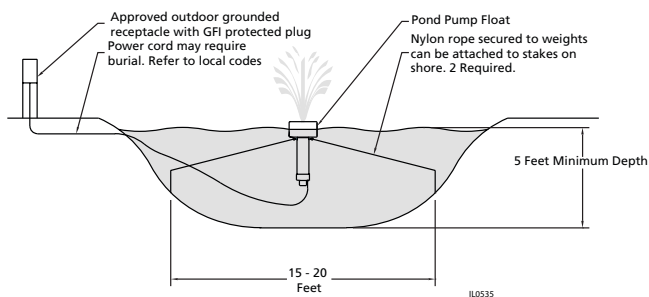

Figure 3: Water Lily - An eye-catching combination spray. Part #2A



INSTALLATION CHECK LIST

- Read installation instructions and warnings.
- Post appropriate warning signs.
- Install desired spray nozzle.
- Install and anchor unit in pond.
- Check insulation resistance to ground.
- Power up unit.
- Test operation of GFCI by pressing the "Test" button.
- File instructions for future reference.

REQUIRED TOOLS AND SUPPLIES

- #2 Phillips screwdriver to change nozzles.
- Nylon rope to anchor unit.
- Stakes or weights for anchoring unit.
- Ohm meter to check insulation resistance to ground.

⚠ CAUTION

WINTER STORAGE

- Rinse unit with clean water to remove any build-up on unit.
- Check unit for any damage.
- Store unit in heated space in freezing climates.

The pump motor is water lubricated and is factory filled with an anti-freeze solution. During operation the antifreeze might exchange, thru the filtered check valve, with the pond water. In climates where freezing may occur, the unit must be stored in a heated storage space to prevent damage to the motor

Figure 2: Sky Cannon - A dramatic single plume of water. Part #2B



Figure 4: Water Trumpet - A symmetrical inverted bell-shape. Part #2C



INTERNAL PARTS



Item #	Qty	Part No.	Description
1	6	021766	Screw - #10 x 3/4 Slotted Head or Pan Head Sheet Metal Screw (18-8 Stainless Steel)
2A	1	021617	Nozzle - Water Lily
2B	1	021618	Nozzle - Sky Cannon
2C	1	021619	Nozzle - Water Trumpet
3	1	021622	O-Ring - AS568A - 041 (3" ID x 3/18" OD)
4	6	021628	Bolt - SS 1/4-20 x 3/4
5	6	021629	Lockwasher - 1/4"
6	1	021707	Mounting Flange
7	1	022912	Float
8	1	021713	Pump End
9	1	021740	Motor 1/2 HP 115V
10	4	127021	Locknut - SS 5/16-24
11	1	021715	100 ft. power cord with GFI
12	2	021609	Eye Bolt - SS 1/4-20 x 2-1/2
13	2	021623	Locknut - SS 1/4-20
14	1	022913	Screen
15	1	021611	Screen Cap
16	1	021613	Strain Relief
17	2	021625	Warning Decal

*Standard hardware item, available locally

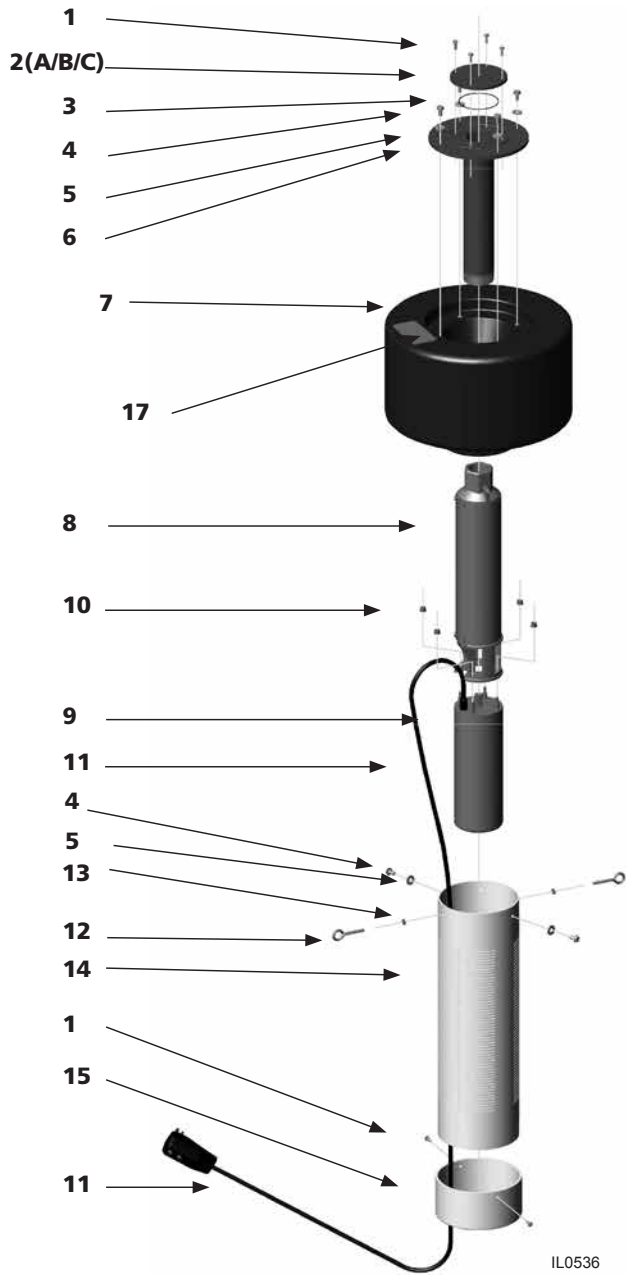

IL0536

Flow (GPH)	Spray Height (Ft.)	Pattern Image	Pattern Name
4900	15		Water Lily - 2A
3300	15		Sky Cannon - 2B
2700	13		Water Trumpet - 2C

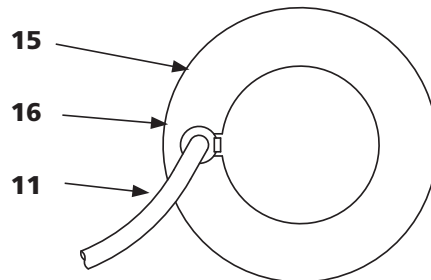

IL0538